

3) Install the Shade

Attach the bracketrail system to the wall brackets by holding the bottom lip of the bracketrail system up to the bottom of the wall bracket that is already mounted on the wall. While holding the bottom of the bracketrail system in place, gradually bring up the top lip of the bracketrail system to the top of the wall bracket. Press firmly until you hear an audible click.



First hold the bracketrail system in place with the bottom lip on the bottom of the wall bracket.



Press the top of the bracketrail system onto the top of the wall bracket until you hear an audible click.

Cassette System Installation

1) Mount the Brackets

Mount the brackets to the wall or window frame, with the outside brackets no further than 2" (5 cm) from the ends of the headrail. On wide shades, space the additional bracket(s) at equal intervals.

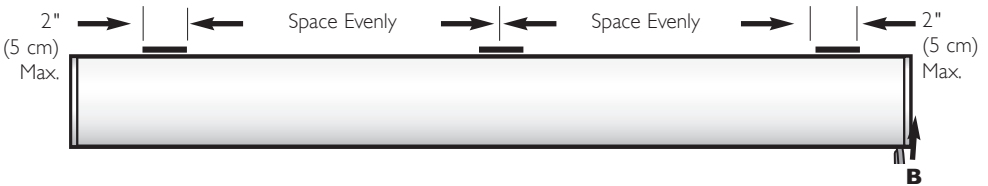

For wall or outside mounts, use the rear bracket holes.

Make sure the release tab is always mounted on the bottom.

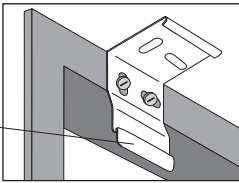

For inside or ceiling mounts, use the top bracket holes.

Make sure the release tab is always mounted on the bottom.

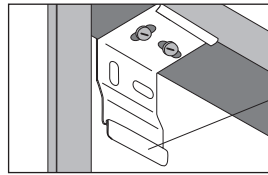

2) Mount the Headrail

Position the headrail with the front panel (A) resting on the top lip of all brackets. Push the bottom front of the headrail firmly backwards and toward the window until the lip on the rear of the headrail engages the bracket and snaps into place, (B) as shown.

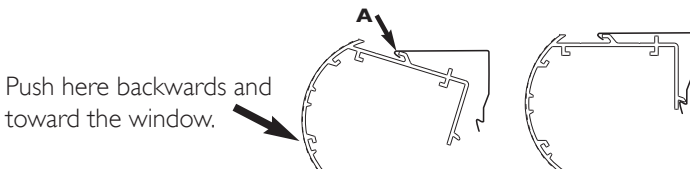

Cordless Roller Shades

Installation Instructions



IMPORTANT: To prevent accidental damage to fabric, **DO NOT** open or cut the packaging around your shade with a utility knife or razor blade.

1) Mount the Bracketrail

The shade will come pre-installed on the white bracketrail system. If the clutch is on the left end of the shade, reverse the bracket positions, left for right. Attach either the pin-end, screw adjust bracket, or wheel adjust bracket to the other side.

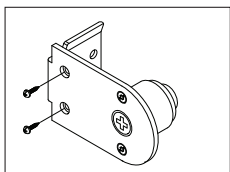
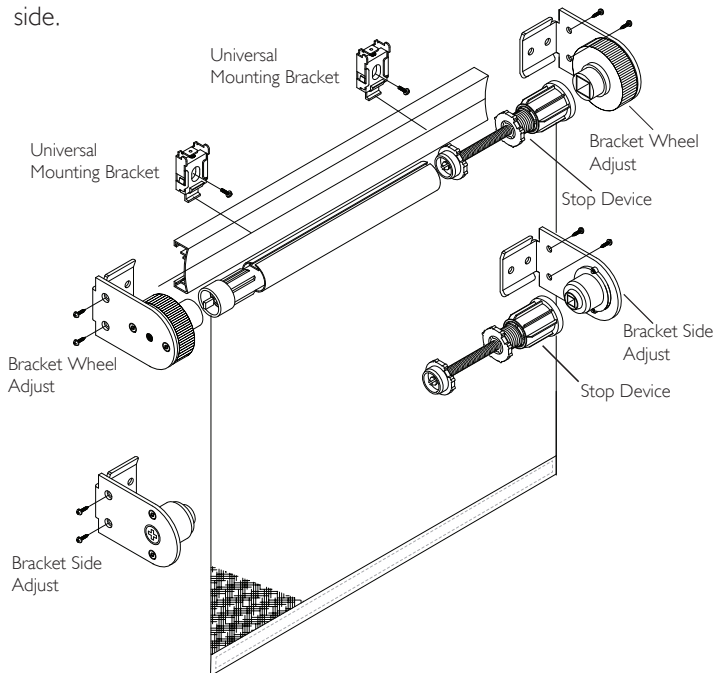

Side Adjust Mounting Bracket

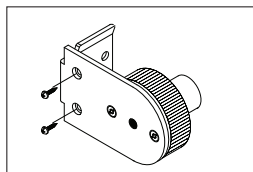

Wheel Adjust Mounting Bracket

2) Mount the Wall Brackets

This system utilizes wall brackets provided (pictured below). Mount the wall brackets evenly spaced and approximately 1/2" above the opening on the

