

1" & 2" Aluminum Blind Installation Instructions

Please follow these Installation Instructions

You will need a pencil, tape measure, drill, screwdriver, pliers, and appropriate fasteners.

Step 1: Choose the Correct Fastener

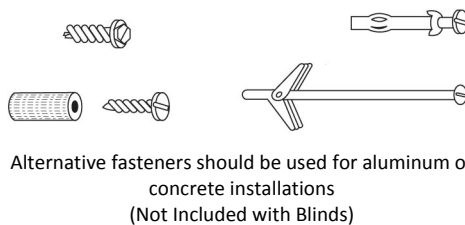

Step 2: Prepare Brackets

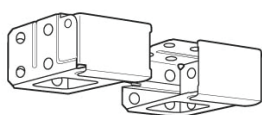

End Box
Installation Brackets

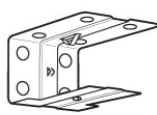

Center Support
Bracket

Prepare box brackets for installation:

Open the front of the bracket by pressing on the bottom of the bracket to release the locking tab while lifting the front gate.

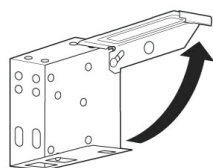

Step 3: Mark the Bracket Locations

(For Outside Mount Installations)

Position the box brackets at each end of the headrail. When using a single center support bracket, center it between the box brackets. For more than one center support bracket, space the support brackets evenly, not more than 30" apart. Make sure the brackets will not interfere with the cord mechanism or any other internal parts. Mark the bracket for mounting hole locations, making sure they are square and equally spaced. For outside mount installations, use a level to check for levelness.

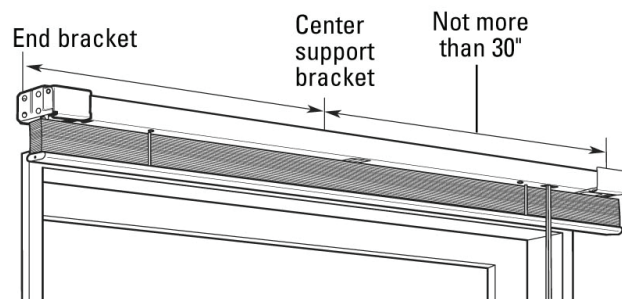

(For Inside Mount Installations)

Position the box brackets at each end of the headrail. Depending on the installation location, box brackets can be attached using the top, back, or side holes. When using a single center support bracket, center it between the box brackets. For more than one center support bracket, space the support brackets evenly, not more than 30" apart. Make sure the brackets will not interfere with the cord mechanism or any other parts. Mark the location of the desired bracket mounting holes, making sure that they are square and equally spaced.

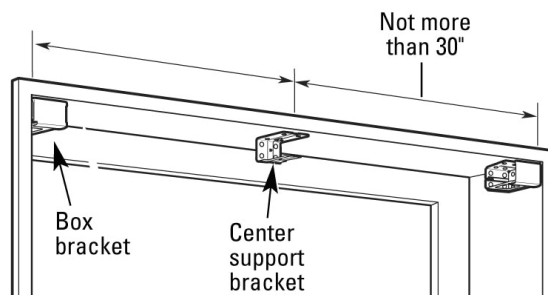

1" & 2" Aluminum Blind Installation Instructions

Step 4: Bracket Installation

(For Outside Mount Installations)
Screw brackets into wall as shown.

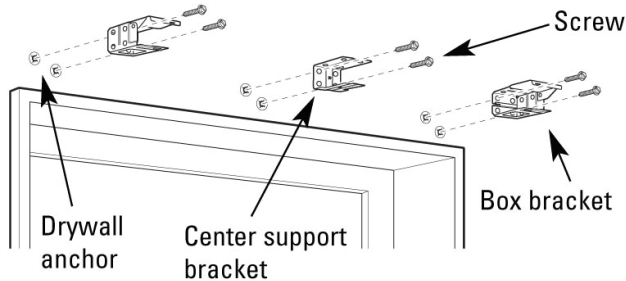

(For Inside Mount Installations)
Screw brackets in window frame as shown.

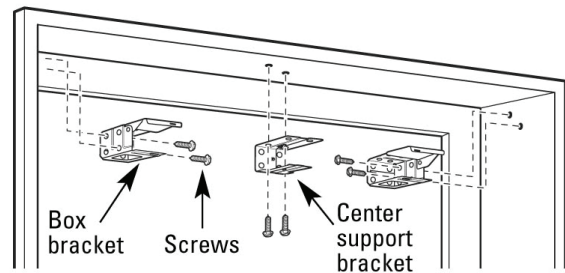

Step 5: Valance Installation

Attach the plastic valance clips to the front of the headrail, one at each end. Space any remaining clips evenly. Hold the valance into the clips.

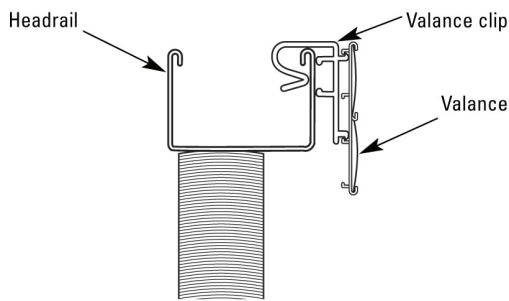

Outside Mount Valances: For aluminum blinds ordered as outside mount, the aluminum slats used for the valance, will be made wider than the headrail. Attach the slats to the plastic valance clips, and then bend both the left and right sides of the valance so that the aluminum valance slats cover the box installation brackets.

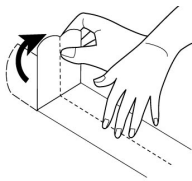

Step 6: Blind Installation

Align the headrail with the center support and box brackets. The headrail should have the tilt mechanism facing toward the room. Be careful not to trap the top slat in the brackets and slide the headrail straight back until it is snug in the brackets. If the headrail can slide from side to side in the box brackets, you can use a flat head screwdriver to bend out the tabs on the end of the until it is snug.

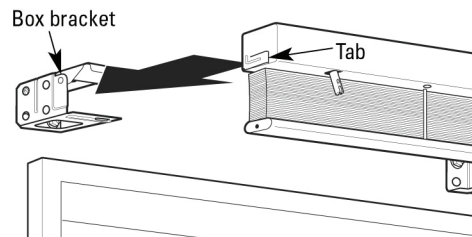

Lower the front gate of each box bracket and press until the locking tab clicks into place.

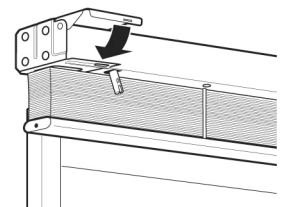

Step 7: Attach Hold Down Brackets

(Optional—Typically used for door installations)

With the hold-down brackets attached to the bottom rail, lower the blind to the hold down bracket mounting surface and mark the bracket locations. Attach the hold down brackets at the bottom of the window or door with the included screws as shown. To attach the bottomrail, gently pull the brackets out slightly, and insert the pins into the holes on the bottomrail of the blinds.

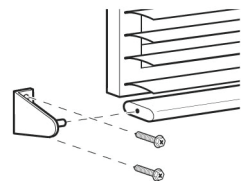

To lower the blind, pull the cord down and towards the center of the shade to unlock the cord. Then, slowly release the cord until the shade reaches the desired location. Move the cord past the outer edge of the shade and let go to lock the cord.

To raise the blind, pull the cord straight down until the shade reaches the desired location. Move the cord past the outer edge of the shade and let go to lock the cord.