

## BASICS

A few simple tools are required:

- Measuring tape
- Power drill, drill bits
- Hex head and/or Phillips driver bit
- Pencil

Additional fasteners other than those sent with your shade may be required depending on the mounting surface. Wallboard and plaster require the use of anchors such as expansion or toggle bolts. Brick, tile or stone need special plugs and drill bits. Remember to always pre-drill holes in wood to avoid splitting.

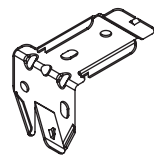

Standard Mounting Bracket

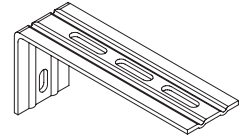

Optional Extension Bracket

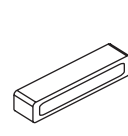

Optional Spacer Block

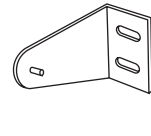

Optional Hold Down Bracket

## BRACKET INSTALLATION

Shades are shipped with the required number of brackets for proper installation. End brackets should be located approximately 3" from either end. Depending on the width of the shade, additional brackets may be necessary, evenly spaced between the two end brackets.

For shade widths of:	Use this Number of brackets:
Up to 40"	2
40" - 72"	3
72" - 84"	4
84" and up	5

Using the Installation Bracket as a template, measure to the edge of the bracket and mark the hole locations with a pencil for drilling. When mounting brackets, make sure they are in line and level.

**Brackets must be in line and level.** Shim brackets on inside mounts if necessary. The headrail must be level for the shade to operate properly.

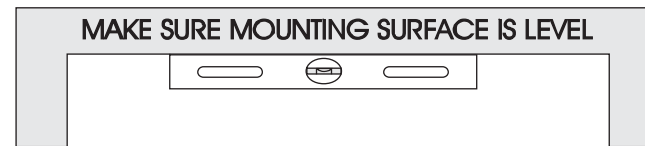

### Inside or Ceiling Mounts

Use the top bracket holes.

Shallow Mount - min. 1" surface  
Flush Mount - min. 2 1/4" surface

Note: Release tab is at the bottom of the bracket

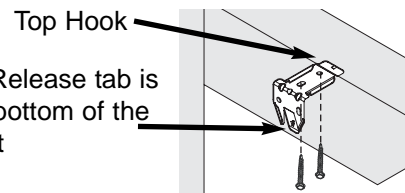

### Wall or Outside Mounts

Use the rear bracket holes.

Outside Mount - min. 7/8" surface

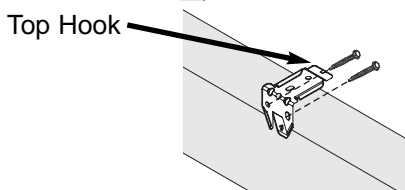

### Outside Mount with Spacer Block

Optional Spacer block will project bracket 3/8".

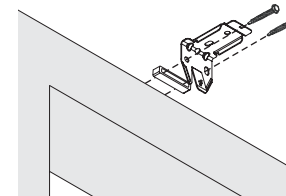

### Outside Mount with Extension Bracket

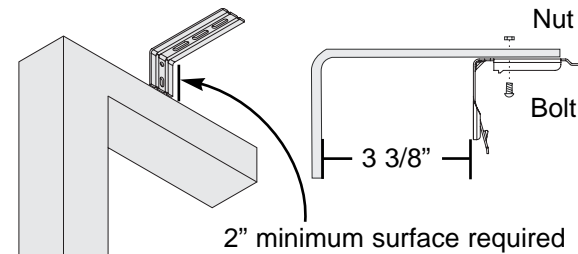

### Sidemount with Extension Bracket

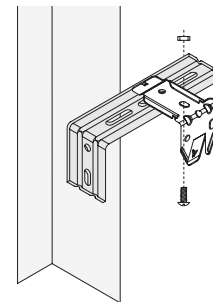

## INSERTING THE HEADRAIL

First, lower the middle and bottom rail about an inch. This will help keep the fabric from getting caught between the brackets and the headrail.

Position the headrail with the front lip (A) resting on the top hooks of all the brackets. Make sure that no fabric is pinched between the brackets and the headrail.

Push the bottom of the headrail firmly upwards and toward the window until the groove at the bottom of the headrail snaps into place, (B) as shown.

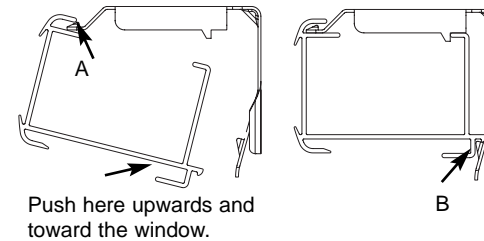

## REMOVING THE HEADRAIL

To remove a shade, insert a screwdriver between the headrail and the bottom back of the bracket (tab which extends out slightly from each bracket).

Gently pry the screwdriver to release the bracket from the headrail. Take care not to damage the painted finish of the headrail.

As you release the brackets, support the headrail to keep it from falling.

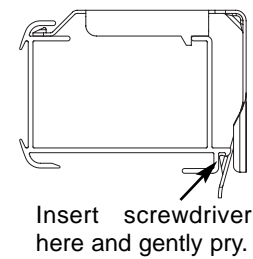

## INSTALLING THE HANDLE

Locate the center of the bottom rail. Gently lift fabric out of the way. Hook the top of the handle over the front lip on the bottom rail. Rotate handle down until it snaps into place. If shade is a duofold, repeat the process for the handle on the middle moving rail.

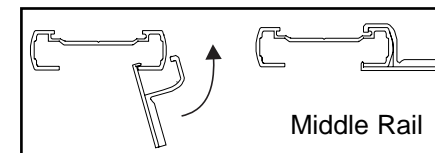
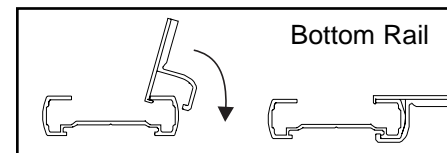

## OPTIONAL HOLD DOWN BRACKETS

Optional Hold Down Brackets are mounted with the supplied screws. With the shade at its proper drop, place the pin of each Hold Down into the hole in each End Cap and mark the screw holes. Make sure the pins are level and aligned. Raise the shade, then screw the Hold Down Bracket into the mounting surface.

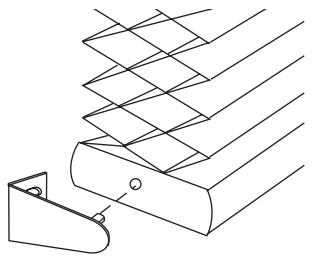

## OPERATION

To lower the shade, pull down on the handle which is secured to the middle or bottom rail. To raise the shade, push the middle and/or bottom rail up. The shade will hold at any position when the middle or bottom rail is released.

This product should be operated from the center of the middle or bottom rail.

**Be sure to raise the shade slowly and steadily to allow the shade enough time to stack evenly.**

Use handle when raising and lowering shade for better support and smoother operation.

For out-of-reach operations, an optional extension pole should be used.

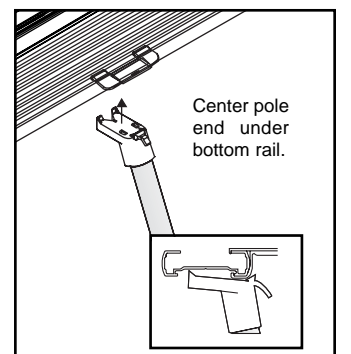
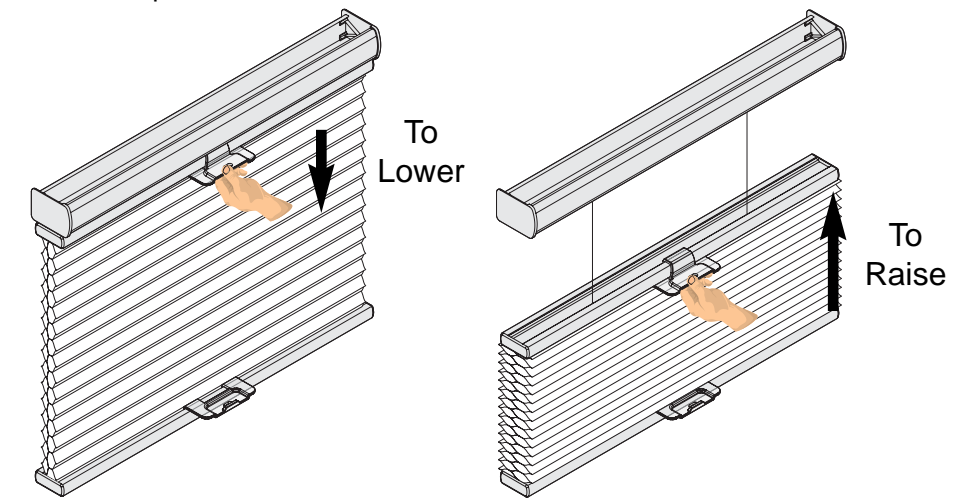
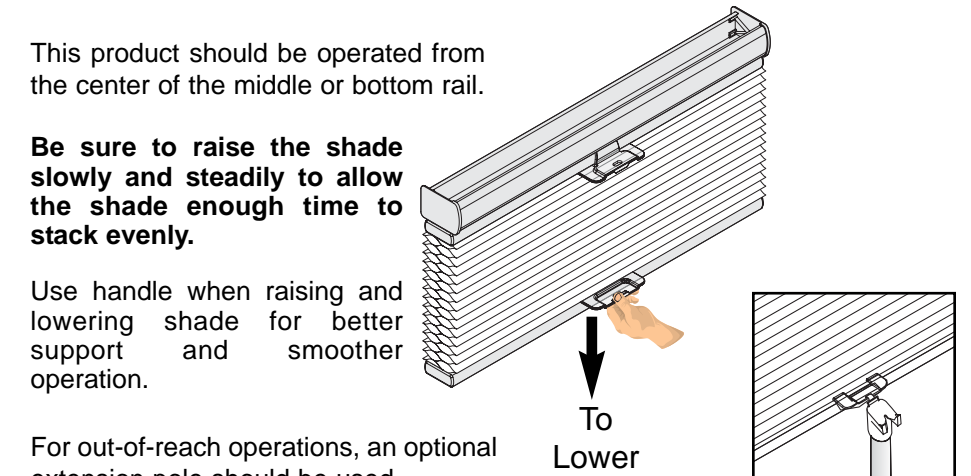

## ADJUST LENGTH OR EQUALIZATION ON SHADES

**NOTE: Only adjust one cord at a time. Disconnecting more than one cord may allow the cords to retract into the headrail.**

If the shade length and equalization is satisfactory, simply trim the excess cord hanging below the bottom rail.

If adjustments are necessary, pull the excess cord at the bottom of the shade down until the Bottom Rail Plug is released (fig. A). Push the cord up or down through the Bottom Rail Plug (figs. B & C).

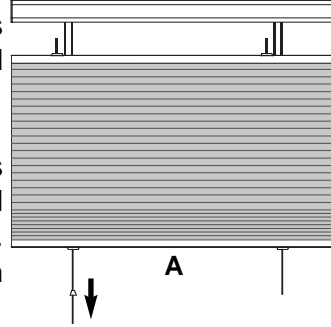

If the cord needs to be longer, slide the bottom end of the cord up into the wedge and slide the wedge down to take up slack.

If the cord needs to be shorter, slide the top end of the cord down into the wedge and slide the wedge up to take up slack.

Adjust the position of the plug as necessary (fig. D).

Feed the cord back through the Bottom Rail Plug (figs. E & F).

Push the Bottom Rail Plug back into the Bottom Rail Pocket.

When bottom rail adjustments have been made, trim the excess cord hanging below the bottom rail.

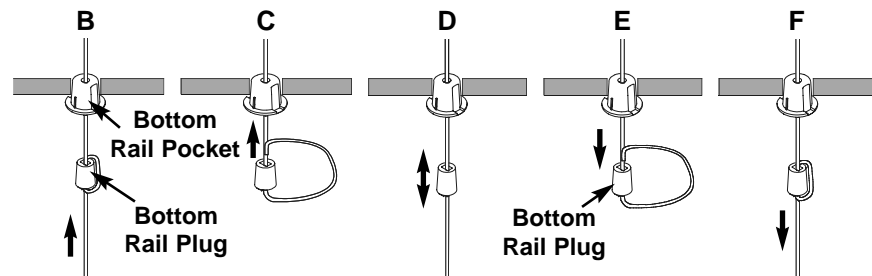

## CLEANING AND CARE

The Honeycomb fabric is easy to care for. Regular dusting with a feather duster or vacuum cleaner brush is recommended. Most stains can be blotted with a damp sponge and mild detergent. For problem stains, the shade can be removed from the Installation brackets and soaked in warm water.

**IMPORTANT: Do Not immerse headrail in water.** When damp, raise shade tightly to re-crisp pleats. Before using anything stronger than mild detergent and lukewarm water, test an unobtrusive corner of the shade. If you have any questions, call your dealer for advice.

## TROUBLE SHOOTING

**1 Problem:** Shade will not stay down.

**Cause:** Because the shade was fabricated primarily in the closed position, the fabric may want to spring up.

**Repair:** With clean hands, gently pull down on a section of cells to relax the pleats (see diagram below). Repeat with another section of cells until the fabric is sufficiently relaxed. Do not tightly stack the shade for 24 hours.

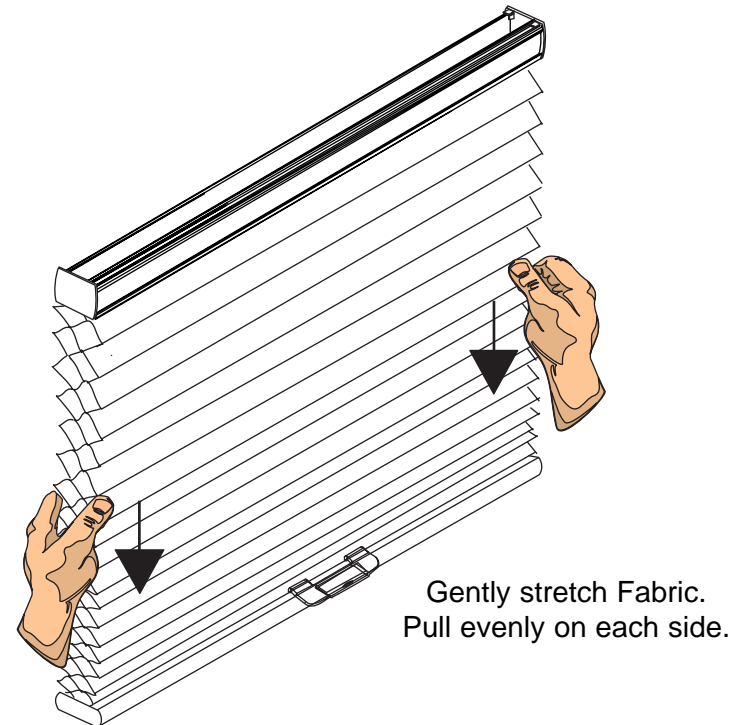

**2 Problem:** Fabric billows out when shade is raised.

**Cause:** Fabric can take a set when stretched out for extended periods of time.

**Repair:** Raise the shade very slowly to allow the retraction mechanism to overcome the force of the stretched fabric.

# Cordless Ultra

## Standard and Duofold Installation Instructions

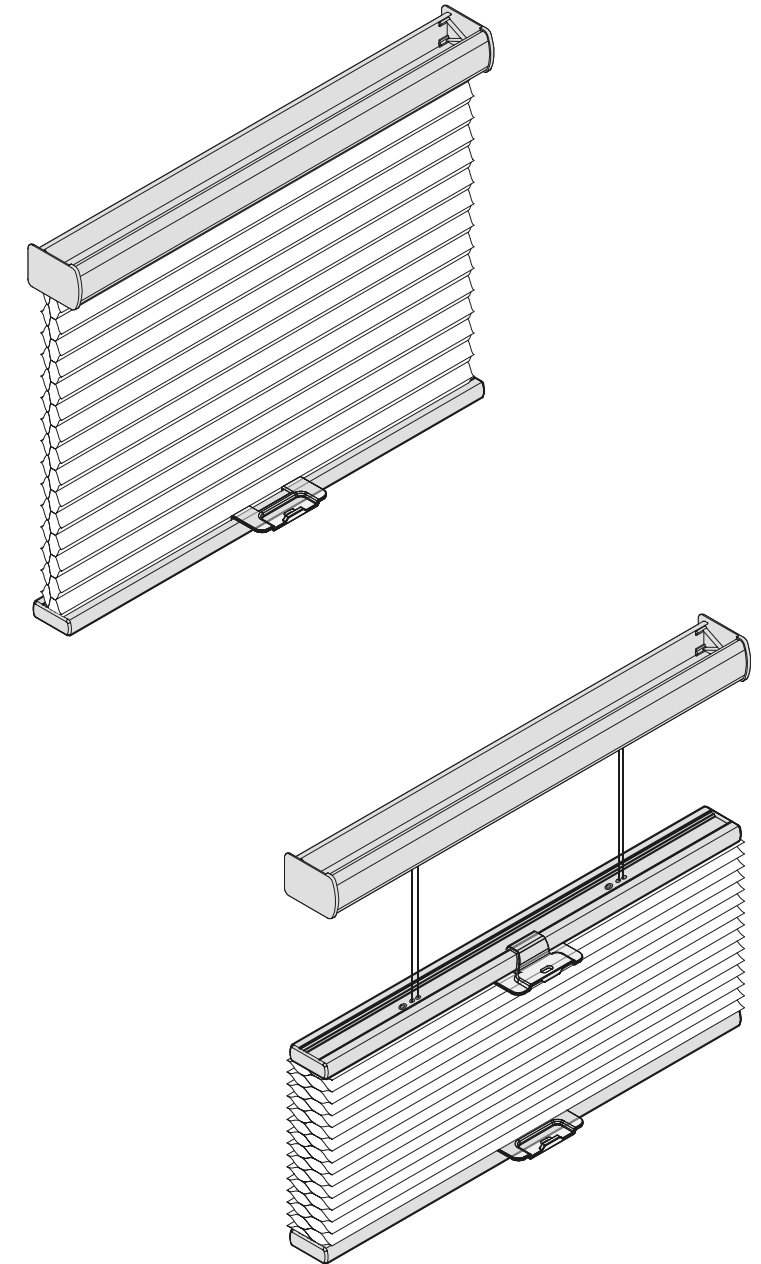

Cellular Window Fashions represent a design breakthrough in style, efficiency and function. The cellular structure and unique hardware system are designed to provide years of reliable service when properly installed.

Please take a few minutes to read through these instructions before beginning.